

Ticona

Designing with Fortron[®] Polyphenylene Sulfide

Design
Manual
(FN-10)



Ticona

Foreword

The *PPS Design Manual* represents a compilation of design information to provide general guidelines for broad classes of Fortron® PPS material. We hope that this publication enables the designer to better understand the behavior of this high-performance material. Thus, after a brief overview (Ch. 1), the following chapters deal with the behavior of Fortron® PPS with regard to its physical and thermal properties (Ch. 2), mechanical properties (Ch. 3), dimensional stability (Ch. 4), its behavior in chemical environments (Ch. 5), and its electrical properties (Ch. 6). The book then discusses fundamental design criteria both for part design and for tool design (Ch. 7), recommended methods and specifications for assembly (Ch. 8), and finally, secondary operations with Fortron® PPS (Ch. 9).

For a discussion of general issues to be considered in designing for plastic parts, the reader is encouraged to study *Designing with Plastic: The Fundamentals* (TDM-1), which is also published by Ticona. Grade-specific information is not given in the *Fortron® PPS Design Manual*, which is a product-specific publication. For grade-specific information, the reader is referred to Fortron® Material Monographs in the area of specific interest, e.g., tensile strength, stress-strain data, fatigue data, and long-term properties of specific grades of Fortron® PPS.

This layered structure of publications enables Ticona to provide detailed, product-specific information more quickly and efficiently than incorporating all such information in one large volume, when often only small parts of such a publication are needed by the designer. Such a structure also allows for quick updates as specific product data are made available.

We hope that this manual helps you, the design engineer, to more accurately predict the behavior of Fortron® PPS, and thus, to better design with this high-performance polymer. We welcome your comments and suggestions for improving this manual in future editions.

Table of Contents

Chapter 1. Overview	1-1
Chemistry of Fortron® PPS	1-1
General Characteristics of Fortron® PPS	1-1
Reinforcements and Fillers	1-1
Flash	1-1
Product Support	1-1
Agency Approvals	1-1
Safety and Health Information	1-1
Chapter 2. Physical and Thermal Properties	2-1
Crystallinity	2-1
Glass Transition Temperature (T_g)	2-1
Thermal Degradation via Thermogravimetric Analysis (TGA)	2-1
Oxygen Index	2-2
Smoke Density	2-2
Chapter 3. Mechanical Properties	3-1
Poisson's Ratio	3-1
Stress-Strain Properties	3-1
Temperature Dependence of Mechanical Properties	3-1
Heat Aging	3-2
Creep Modulus	3-2
Compressive Creep	3-2
Molding Temperature Effects	3-2
Weld Line Strength	3-3
Fatigue Resistance	3-4
Impact Strength	3-4
Anisotropic Effects	3-4
Use of Regrind	3-4
Abrasion Wear	3-4
Coefficient of Friction	3-5
Chapter 4. Dimensional Stability	4-1
Coefficient of Linear Thermal Expansion	4-1
Shrinkage from Injection Molding	4-1
Warpage	4-2
Annealing	4-3
Tolerances with Injection Molding	4-4
Moisture Absorption	4-4
Chapter 5. Chemical Resistance	5-1
Effects of Hot Water	5-1
Chemical Resistance	5-1

Table of Contents (Continued)

Chapter 6. Electrical Properties	6-1
Effect of Frequency, Humidity, and Temperature	6-1
Soldering Heat Resistance	6-2
Ionic Impurities	6-2
Chapter 7. Fundamental Design Criteria	7-1
Part Design	7-1
<i>Wall Thickness</i>	7-1
<i>Fillets/Radii</i>	7-1
<i>Ribs</i>	7-1
<i>Bosses</i>	7-1
Tool Design	7-2
<i>Tool, Screw, and Barrel Construction Materials</i>	7-2
<i>Gate Location</i>	7-2
<i>Gate Size</i>	7-2
<i>Gate Types</i>	7-2
<i>Runner Systems</i>	7-2
<i>Vents</i>	7-2
Chapter 8. Assembly	8-1
Snap-Fits	8-1
Chemical Bonding/Adhesives	8-1
Ultrasonic Welding	8-1
Heat Staking	8-2
Ultrasonic Staking	8-2
Threading	8-3
Metal Inserts	8-3
Chapter 9. Secondary Operations	9-1
Machining	9-1
Surface Decoration	9-1
Colorability	9-1
Drilling and Boring	9-1

Overview

Chemistry of Fortron® PPS

Fortron® products are based on a linear poly (phenylene sulfide) (PPS) polymer, produced by a polycondensation reaction of *p*-dichlorobenzene and sodium sulfide. The reaction yields a PPS polymer with the following structure:

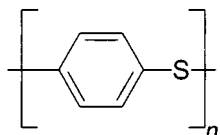

Figure 1 Idealized PPS Structure

General Characteristics of Fortron® PPS

The structure of Fortron® PPS polymer contributes to the following properties:

- High thermal stability
- Excellent chemical resistance
- Inherent flame resistance
- Excellent electrical properties
- Excellent flow

Fortron® PPS is further distinguished from highly branched PPS products by the following performance advantages:

- Higher elongation and impact strength
- Higher weld line strength
- Lower ionic impurities in base resins and filled products
- A natural color of light beige for the Fortron® PPS base resin for easier coloring
- Consistent flowability (lot to lot)

Most designers choose Fortron® PPS because it demonstrates a valuable combination of properties relative to the load-bearing capabilities and dimensional stability when exposed to chemicals and high-temperature environments.

Reinforcements and Fillers

When fillers, such as glass fibers, minerals, or mixtures of these, are added to the base resin, the load-bearing capability, represented by the heat distortion temperature (HDT), is also raised. The HDT of Fortron® unreinforced PPS is generally 221°F (105°C) at 264 psi, while that of a reinforced Fortron® PPS is 500+°F (260+°C). Because of this added value and Fortron® PPS's affinity for fillers, the majority of PPS applications use glass-reinforced or mineral/glass-filled systems.

Flash

Some degree of flash may be apparent, especially in applications requiring the filling of thin walls over long distances with relatively high pressures. Selection of the proper grade of Fortron® PPS and the use of proper injection molding conditions will aid in minimizing flash. In addition, gate location can be used to decrease the high pressures leading to flash (see "Gate Location" subsection in Chapter 7).

Product Support

Experienced field engineers and design engineers are available to assist you with product design, material specification, and molding trials. For further information or assistance, please contact your representative from the Ticona offices listed on the back cover of this publication.

Agency Approvals

Fortron® PPS has been granted ratings by Underwriters Laboratories of UL94V-0 to 0.031 in. (0.79 mm) thickness and UL94-5VA at 0.125 in. (3.18 mm) on many filled grades, as well as ratings of A00 and V0 by the CSA (Canadian Standards Agency). UL yellow cards are available upon request. Please contact your Fortron representative. Some Fortron® PPS grades have also been approved under Military Specifications M-24519 and M-46174 (ASTM D4067).

Safety and Health Information

The usual precautions employed in working with high-melting plastics should be observed in working with Fortron® polymers.

Consult the current Material Safety Data Sheet (MSDS) prior to use for detailed safety and health information concerning specific Fortron® PPS grades.

Use process controls, work practices, and protective measures described in the MSDS to control workplace exposure.

MSDSs have been developed by Ticona to provide our customers with valuable safety, health and environmental information. A copy of the MSDS for each specific Fortron® PPS grade is available upon request. Please contact your local sales office or call the Technical Information number given at the end of this publication.

Chapter 2

Physical and Thermal Properties

This chapter describes some of the basic characteristics of Fortron® PPS and its thermal capability. The thermal properties discussed here, and shown in Table 1, are due to short-term testing. Long-term thermal properties, such as time-temperature effects both without load (heat aging) and with a load (creep modulus), are discussed in Chapter 3.

The reader is encouraged to review sections of this manual that deal with the thermal stability of Fortron® PPS products, as well as sections that show how dimensional accuracy depends on thermal changes. Finally, a general review of Chapter 4 of *Designing with Plastic: The Fundamentals* (TDM-1) may help the designer deal with the thermal requirements of an application.

Table 1 Thermal and physical properties of Fortron® PPS

Property	Units	40% Glass	Mineral/ Glass	Unfilled
Specific Gravity		1.64	1.8 - 1.99	1.35
Melt Specific Heat	J/g°C	1.5	1.6	1.83
Glass Transition Temperature	°C	90	90	90
Crystallization Temperature (Peak)	°C	125	125	125
Melt Recrystallization Temperature (Peak)	°C	220	215	160 - 250*
Melt Temperature	°C	282	282	282
Heat Deflection Temperature, @ 264 psi	°C	260+	260+	105
Thermal Conductivity	W/m²K			
@ 25°C		0.2	0.3	
@ 125°C		0.2	0.35	
@ 230°C		0.25	0.35	
@ 300°C		0.25	0.35	0.3

* Please note that this range represents the values for a number of different polymers, not a range for one polymer.

Crystallinity

Fortron® PPS is a semicrystalline polymer that consists of both amorphous and crystalline regions. The crystalline regions of neat Fortron® PPS account for 60-65% of the polymer. With the combination of a high degree of

crystallinity and its aromatic structure, Fortron® PPS exhibits a high melt temperature of 285°C (545°F). The polymer crystallizes rapidly above the T_g , as indicated by an exothermic crystallization peak at 120-130°C, as seen in Table 1. From the melt, recrystallization also occurs rapidly at 215-220°C, also seen in Table 1.

Glass Transition Temperature (T_g)

The glass transition temperature, T_g , is the temperature at which the amorphous regions of the polymer become mobile. The significance of this value is that above T_g (about 90°C for Fortron® PPS products), the load-bearing capability is reduced. This is illustrated by the results from a dynamic mechanical thermal analysis (DMTA), a powerful technique used to indicate the stiffness of a molded part as a function of temperature and load. Results from the DMTA cover a range of loads and temperatures.

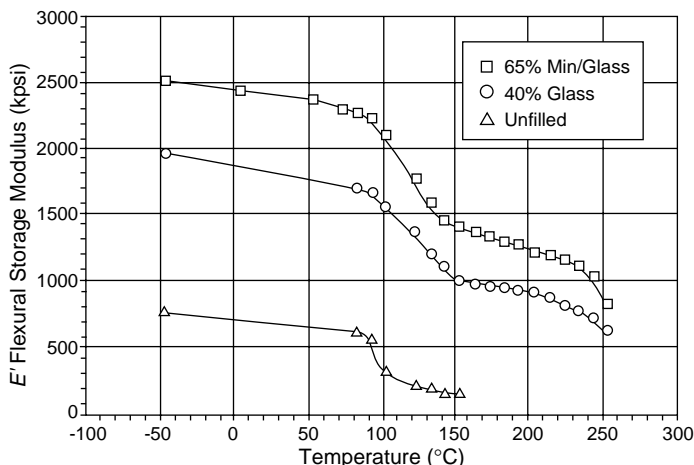

Figure 1 Flexural storage modulus vs. temperature for Fortron® PPS

The flexural storage modulus (E') is one such curve generated by a DMTA for evaluating the load-bearing capability of a material. Figure 1 illustrates the change in stiffness of Fortron® PPS at temperatures both below and above the T_g .

Thermal Degradation via Thermogravimetric Analysis (TGA)

Thermogravimetric analysis is a technique used to evaluate a material's thermal stability. In this test the material is heated until it is melted completely and finally degraded. During the heating process, the weight of the sample is measured at various exposure temperatures. The curve seen in Figure 2 shows that thermal oxidation of 40% glass-reinforced Fortron® PPS occurs well after the melt temperature.

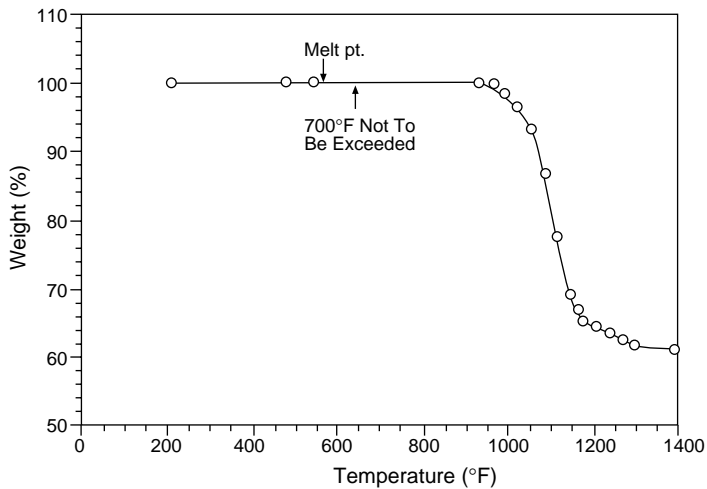

Figure 2 Weight loss vs. temperature for 40% glass-reinforced Fortron® PPS

No particular molding hazards have been identified for molding Fortron® polymers, provided that standard industry practices are followed. Like most thermoplastics, Fortron® PPS will decompose to give off decomposition products, including carbon dioxide, carbon monoxide, sulfur oxides, hydrogen, and methane, if heated to very high temperatures (>700°F). However, Fortron® PPS is stable up to 700°F (370°C), well above the limits of most polymers. As a precaution, sufficient ventilation should always be provided.

To avoid thermal decomposition and evolution of fumes, melt temperatures should not exceed 700°F (370°C), which is well above the normal processing range. Fortron® PPS should not be maintained at processing temperatures for long periods of time. It is recomm-

ended that the molding machine be shut down if it is to be idle for 15 minutes or more.

Oxygen Index

Since the normal atmosphere contains about 21% oxygen, a minimum oxygen index of 28% is required to qualify for a flammability rating of Self-Extinguishing (ASTM D2863). The oxygen index for 40% glass-reinforced Fortron® PPS is 47%, and that for 65% mineral/glass-reinforced Fortron® PPS is 53%, indicating these materials' excellent, inherent flame resistance properties .

Smoke Density

Specimens of 40% glass-reinforced and 65% mineral/glass-reinforced Fortron® PPS were prepared and tested according to procedures established by the National Bureau of Standards (NBS). Flaming and smoldering tests were performed in an NBS smoke density chamber. The results of these tests are presented in Table 2.

The obscuration time is the time for a typical room to reach such a critical smoke density that an occupant's vision would be impaired by smoke and thus hinder his/her escape. This critical level of smoke density or specific optical density (Ds) for obscuring vision is 16.

The test exposes a 3 X 3 in. sample to a circular foil radiometer heat source under flaming or smoldering conditions. Both the heat source and the sample are enclosed in a 3 X 3 X 2 ft cabinet. The smoke density is then measured in terms of light absorption by a photometer.

Table 2 Smoke density data for Fortron® PPS

Property	Flaming		Smoldering	
	40% Glass	65% Mineral/Glass	40% Glass	65% Mineral/Glass
Max. Value of Specific Optical Density (Dm)	95	44	12	10
Dm, Corrected (Dmc)	91	42	11	9
Specific Optical Density @ 1.5 min.	1	0	0	0
Specific Optical Density @ 4.0 min.	18	4	0	1
Obscuration Time (min) (Time to Ds = 16)	4.1	7.1	–	–

Chapter 3

Mechanical Properties

Properties that account for the load-bearing capability of a material are especially important to the designer for determining the proper wall thickness of a geometric part.

The following discussion is presented so that the designer will be able to account for the various effects that temperature, loads, molding conditions, etc. will have on the properties related to structural design.

Poisson's Ratio

Poisson's ratio, ν , is the ratio of lateral strain to longitudinal strain. The value of Poisson's ratio is 0.38 for unfilled Fortron® PPS and 0.35 for glass-reinforced and mineral/glass-reinforced Fortron® PPS.

Stress–Strain Properties

Figures 1 and 2 demonstrate the stress-strain behavior of 40% glass-reinforced and 65% mineral/glass-reinforced Fortron® PPS products at various temperatures. At room temperature the behavior approaches that of an elastic (Hookean) response, due to its high degree of crystallinity and high filler content. At temperatures above T_g , the properties show relatively lower values (see Chapter 2, Glass Transition Temperature section, for explanation).

Temperature Dependence of Mechanical Properties

Knowledge of the dependence of a polymer's mechanical properties on temperature is essential in designing

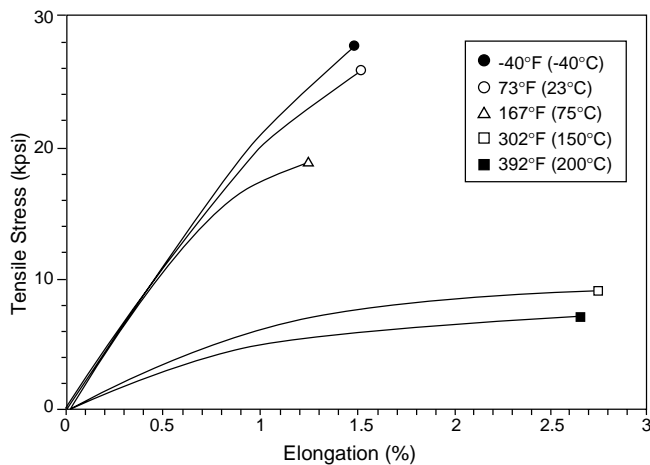

Figure 1 Stress-strain behavior of 40% glass-reinforced Fortron® PPS

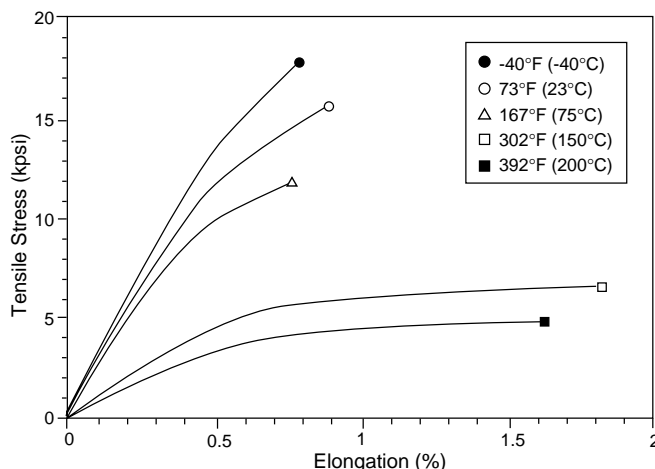

Figure 2 Stress-strain behavior of 65% mineral/glass-reinforced Fortron® PPS

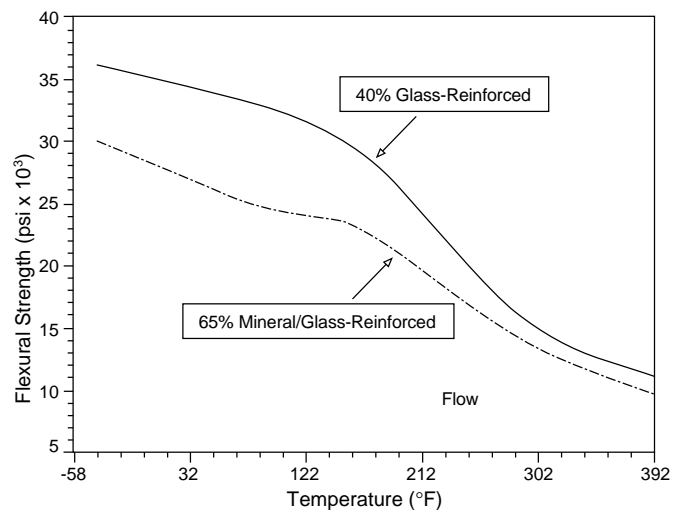

Figure 3 Temperature dependence of flexural strength

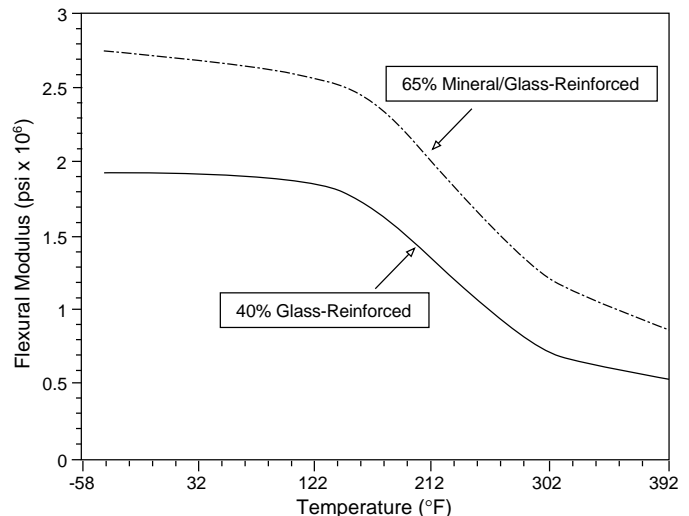

Figure 4 Temperature dependence of flexural modulus

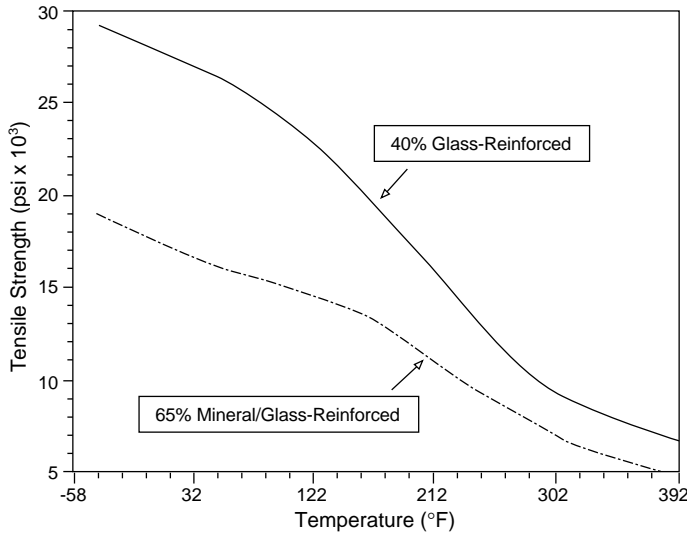

Figure 5 Temperature dependence of tensile strength at break

with that material. Figures 3-6 show the temperature dependence of the flexural strength (Fig. 3), flexural modulus (Fig. 4), tensile strength (Fig. 5), and tensile elongation (Fig. 6) of 40% glass-reinforced and 65% mineral/glass-reinforced Fortron® PPS.

Heat Aging

Fortron® PPS shows little significant change in mechanical properties after prolonged exposure to elevated temperatures. Many Fortron® PPS grades have been granted Relative Thermal Index (RTI) values of 200-240°C (392-446°F) by Underwriters Laboratories. It is significant that these values are higher than those of most other plastics (thermoplastics and thermosets).

Creep Modulus

Fortron® PPS polymers demonstrate outstanding creep properties below T_g (ca. 90°C). Even at elevated temperatures, the creep modulus of Fortron® PPS is excellent when compared to that of other high-performance polymers.

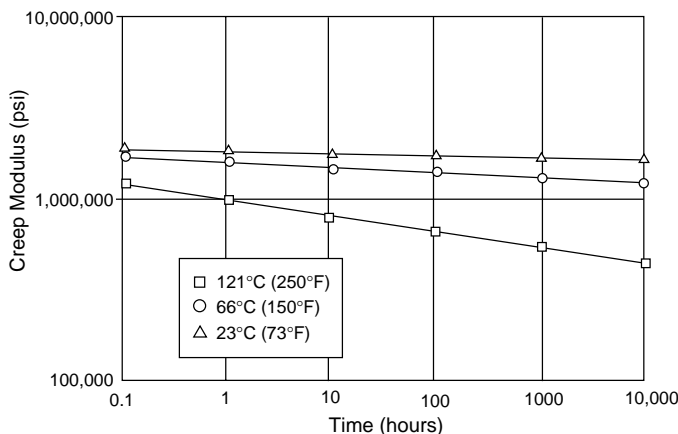

Figure 7 Creep modulus in three-point bending of 40% glass-reinforced Fortron® PPS; stress = 5000 psi

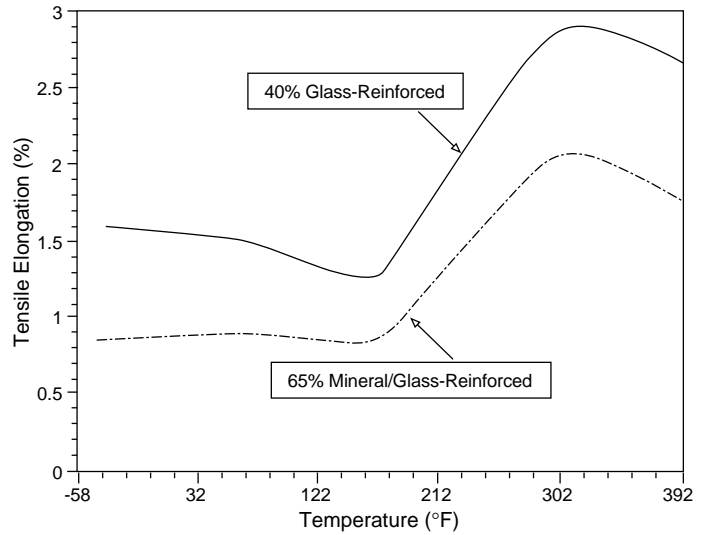

Figure 6 Temperature dependence of tensile elongation at break

Figures 7 and 8 show the creep modulus in three-point bending of 40% glass-reinforced (Fig. 7) and 65% mineral/glass-reinforced (Fig. 8) Fortron® PPS at temperatures ranging from 23 to 120°C (72 to 250°F) under an applied stress of 5000 psi for 10,000 h.

Compressive Creep

Compressive creep data of 40% glass-reinforced Fortron® PPS are seen in comparison with those of several other thermoplastic and thermoset materials, at 200°F for 16 h (Fig. 9A) and 300°F for 24 h (Fig. 9B) under 10,000 psi applied stress.

Molding Temperature Effects

In order to achieve optimal load-bearing capabilities at elevated temperatures, optimal dimensional stability, and a glossy surface appearance, it is necessary to use a mold temperature of at least 275°F. Such a temperature requires the use of electric or, preferably, oil heating systems to maximize the crystallinity. Table 1 shows the

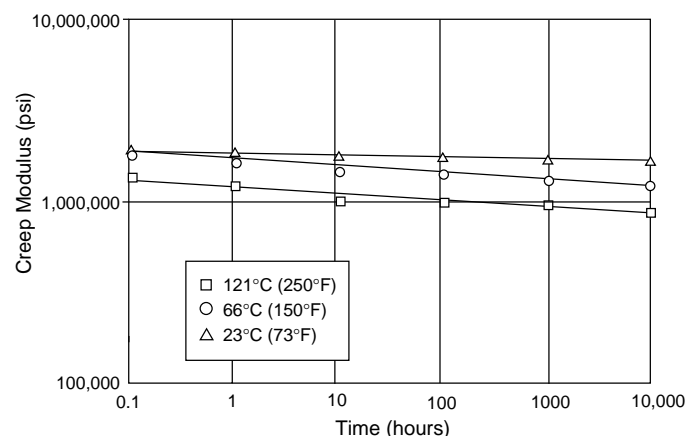

Figure 8 Creep modulus in three-point bending of 65% mineral/glass-reinforced Fortron® PPS; stress = 5000 psi

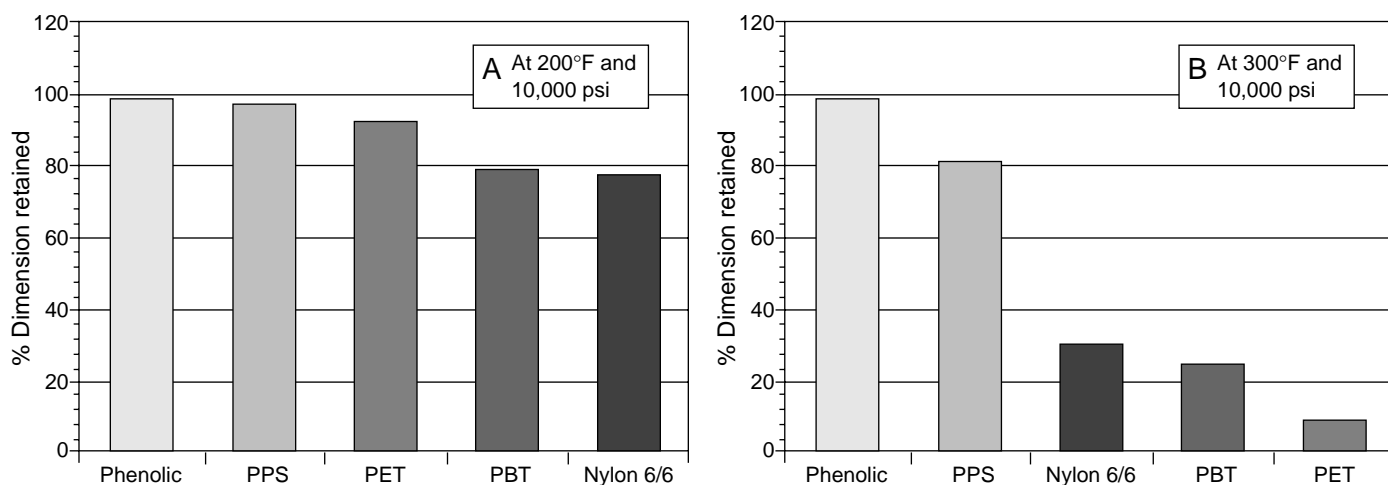

Figure 9 Compressive creep data of thermoset and thermoplastic materials at 200°F for 16 h (A) and at 300°F for 24 h (B)

percent property retention of samples molded at various temperatures, both above and below the optimal mold temperature of 275°F. As shown, the only physical properties to exhibit significant changes are the HDT and the percent crystallinity.

The high surface crystallinity obtained by higher mold temperatures results in a more complete part shrinkage. This is especially important in maintaining dimensional stability at elevated temperatures.

Weld Line Strength

Unlike traditional branched PPS products, Fortron® PPS products exhibit excellent weld line integrity, primarily because of Fortron® PPS's linear structure. Figure 10 compares the tensile strength of both 40% glass-reinforced and 65% mineral/glass-reinforced Fortron® PPS with weld lines with the values of those products without a weld line. Figure 11 compares the weld line strength of reinforced Fortron® PPS products to the

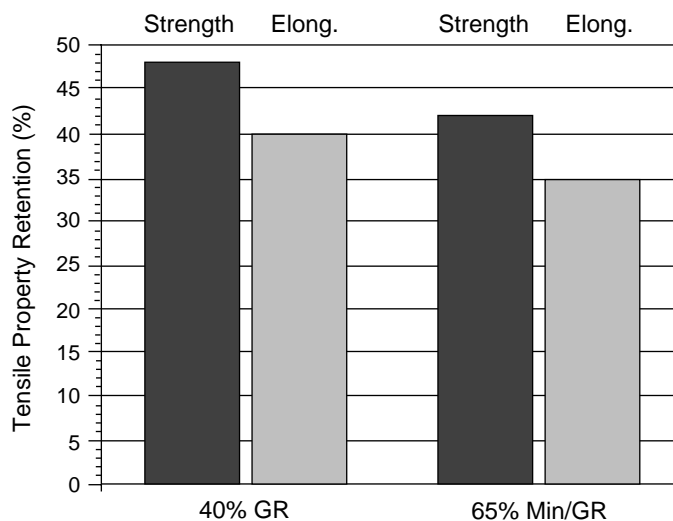

Figure 10 Comparison of tensile strength retention with and without weld lines

Table 1 Percent property retention of samples of 40% glass-reinforced Fortron® PPS molded at various temperatures

Property	% of Property Value at Given Mold Temperature			
	140°F	194°F	248°F	(optimal) 275°F
Crystallinity	10	21	73	100
Heat Distortion Temperature*, °F	185	200	210	500
Tensile Strength	91	96	97	100
Tensile Elongation	109	108	106	100
Flexural Modulus	96	97	97	100
Notched Izod Impact strength	117	108	104	100

* Because one cannot take a percentage of a temperature, the values given here are absolute.

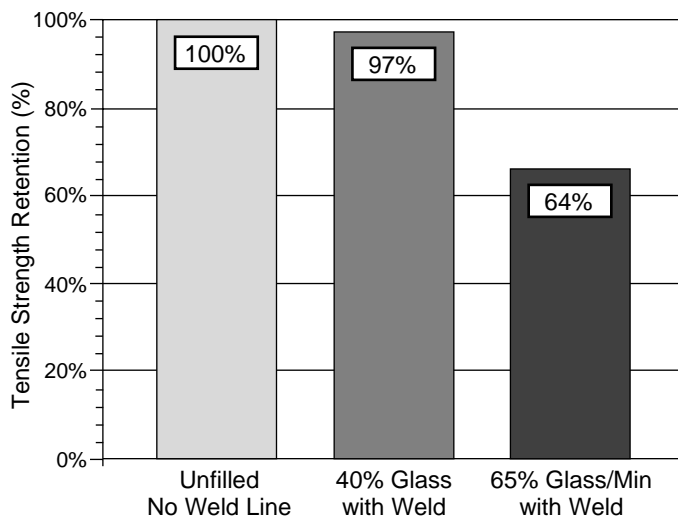

Figure 11 Weld line tensile strength vs. unfilled Fortron® PPS with no weld line

properties exhibited by the base resin without a weld. The significance of this comparison is that it shows the contribution of the weld line strength to the excellent weldability of the base resin.

Fatigue Resistance

Fortron® PPS resins show a high resistance to fatigue from repeated stress, provided that the ultimate elongation of the material is not exceeded. The ultimate elongation of glass-reinforced and mineral/glass-reinforced Fortron® PPS products is ca. 1%. Figures 12 and 13 show the fatigue resistance of 40% glass-reinforced Fortron® PPS at 23°C and 65% mineral/glass-reinforced Fortron® PPS both at 73°F (23°C) and at 320°F (160°C).

Impact Strength

The toughness of Fortron® PPS products can be best described by the energy required to initiate a crack, as well as by the total impact energy required to break through a sample. Results were obtained by using the multi-axial impact test, outlined by ASTM Method D3763, which requires dropping a dart, in this case at 5 mph, onto a 4-in. disk (1/8 in. thick). Table 2 illustrates the results of this test obtained with Fortron® PPS and a highly branched PPS product.

Anisotropic Effects

The mechanical properties in the flow direction of a part are greater than those in the transverse direction, due to glass fiber orientation. Table 3 gives the ratio of transverse direction (D_t) to flow direction (D_f) for the flexural strength, the flexural modulus, and the tensile strength and elongation at break of Fortron® PPS products.

Use of Regrind

The use of regrind can affect the mechanical properties of a molded part. However, it is worth noting that

Table 2 Results of Drop Dart Impact Test (ASTM D3763, 5 mph)

Material	Crack Initiation Energy (ft-lb)	Total Energy to Break (ft-lb)
40% Mineral / Glass Fortron® PPS	5.66	7.20
Mineral / Glass Fortron® PPS	2.85	4.77
40% Mineral / Glass Highly Branched PPS	2.60	4.30
65% Mineral / Glass Highly Branched PPS	2.25	4.22

Fortron® PPS products show very little loss in properties when regrind is used. Table 4 demonstrates the effect of five moldings using 100% regrind on several important mechanical properties. This set of data demonstrates the thermal stability of Fortron® PPS. It is recommended, however, that the maximum use of regrind be limited to 25%.

Abrasion Wear

The amount of wear caused by abrasion against a part can be due to a number of factors, e.g., the velocity of the moving parts, the nature of the abrasive substance, the temperature, and the load applied.

Abrasion wear results for Fortron® PPS are tested by ASTM D1044, using the Taber abrasion apparatus. In this test a specimen is mounted on a turntable so that it is in contact with a 1-kg CS-17 abrasive wheel. After the specified number of revolutions at constant speed, the weight loss of the specimen is determined in milligrams.

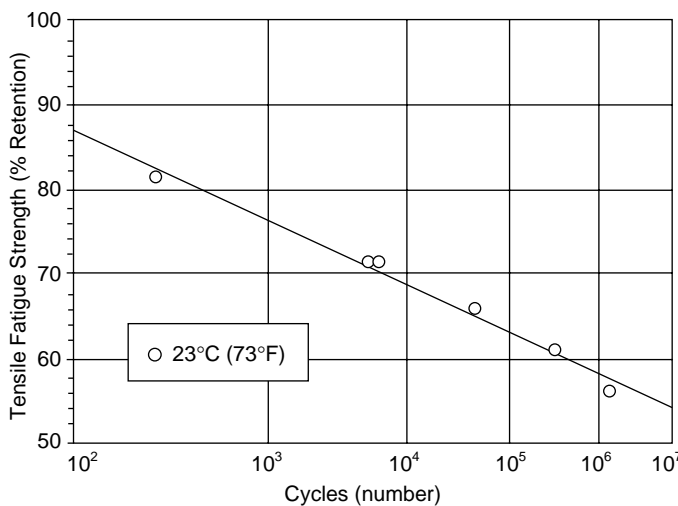

Figure 12 Fatigue resistance of 40% glass-reinforced Fortron® PPS

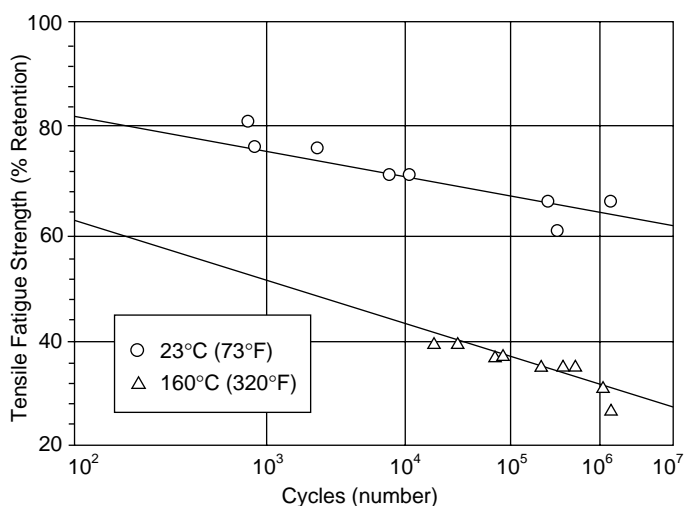

Figure 13 Fatigue resistance of 65% mineral/glass-reinforced Fortron® PPS

Table 3 Anisotropic effects on mechanical properties at 23°C

Material	Dt/Df (%)			
	Flexural Strength	Flexural Modulus	Tensile Strength	Tensile Elongation
40% Glass-Reinforced Fortron® PPS	50	60	55	65
Mineral/Glass-Reinforced Fortron® PPS	35	68	55	50

Table 4 Effect of regrind on mechanical property retention

Property	ASTM Method	Initial Value	40% Glass-Reinforced after 5th Molding	65% Mineral/Glass-Reinforced after 5th Molding
Tensile Strength	D638	100%	81%	79%
Elongation	D638	100%	82%	83%
Flexural Strength	D790	100%	88%	82%
Flexural Modulus	D790	100%	84%	95%

Table 5 Weight loss due to abrasion of Fortron® PPS (ASTM D1044)

Material	Weight Loss (mg)
40% Glass Reinforced	
First 1000 Cycles	35
1000-10,000 Cycles	11
40% Mineral/Glass Reinforced (Low Wear Grade)	
First 1000 Cycles	25
1000-10,000 Cycles	9
Mineral/Glass Reinforced	
First 1000 Cycles	43
1000-10,000 Cycles	13

The weight loss values for 40% glass-reinforced Fortron® PPS and for 65% mineral/glass-reinforced Fortron® PPS due to abrasion are shown in Table 5.

Coefficient of Friction

The static and sliding coefficients of friction of 40% glass-reinforced Fortron® PPS against steel, aluminum, and brass are shown in Table 6. These results represent the average of samples from one molding, and are tested according to ASTM Method 1894-63.

Test conditions are as follows:

- Specimens: 2-in. discs
- Contact area: 3 in.²
- Force: 1 lb weight
- Speed: 5 in./min
- Temperature: 72°F

Table 6 Coefficient of friction of Fortron® PPS

Material	Coefficient of Friction	
	Static	Dynamic
Steel	0.23	0.23
Aluminum	0.20	0.22
Brass	0.25	0.25

Chapter 4

Dimensional Stability

Dimensional Stability

It is important for the part designer to understand the exceptional dimensional control obtainable with Fortron® PPS. We consider possible tolerances, as well as the dimensional effects caused by shrinkage, annealing, and moisture absorption. Dimensional effects caused by exposure to various chemicals are treated in Chapter 5.

Coefficient of Linear Thermal Expansion

The coefficient of linear thermal expansion is the slope of the curve divided by the specimen length, i.e., Δ dimension/ $(\Delta$ temperature X length). Figures 1 and 2 show the dimensional change for both the flow and transverse directions of mineral/glass-reinforced and 40% glass-reinforced Fortron® PPS, respectively. The curves are measured by the Perkin-Elmer Thermomechanical Analyzer (TMA 7) from -13 to 392°F (-25 to 200°C), ASTM Test Method E831.

At the glass transition temperature, T_g , the rate of expansion changes. Above the glass transition temperature, the rate of thermal expansion may shift due to an increase in molecular chain motion and its attendant effects, stress relaxation and/or crystallization. Thus, samples molded from different sources and under different conditions will probably yield results significantly influenced by the processing and end-use thermal history. This is especially true of data taken in the transverse direction, where the effects of orientation and processing are most pronounced.

Shrinkage from Injection Molding

Typically, the mold shrinkage of Fortron® PPS products is very low, and therefore, quite suitable for precision molding. Typical shrinkage values for Fortron® PPS products are as follows:

40% Glass-Reinforced:

- Flow Direction: 0.002-0.006 in./in.
- Transverse Direction: 0.004-0.006 in./in.

Mineral/Glass-Reinforced:

- Flow Direction: 0.002-0.006 in./in.
- Transverse Direction: 0.003-0.007 in./in.

Low Warp Mineral / Glass-Reinforced

- Flow Direction: 0.003-0.006 in./in.
- Transverse Direction: 0.004-0.007 in./in.

While the shrinkages given above are typical, these values vary, depending on the variables listed on p. 4-2 under Warpage. It is highly recommended that prototyping be employed prior to cutting a tool to determine the proper shrinkage for a given part. If prototyping is not economical then for safety it is recommended that oversized cores and undersized cavities be cut, since it

is always easier and less expensive to cut steel than to add it.

The effect of part thickness on shrinkage of 40% glass-reinforced and mineral/glass-reinforced Fortron® PPS is shown in Figure 3. The reason for greater shrinkage in thicker parts is that thicker parts exhibit slower cooling, which results in a greater degree of crystallization, thus causing more shrinkage. Figure 4 illustrates the effect of filler/reinforcement level on shrinkage of Fortron® PPS: as filler level increases, shrinkage decreases and becomes less sensitive to part thickness.

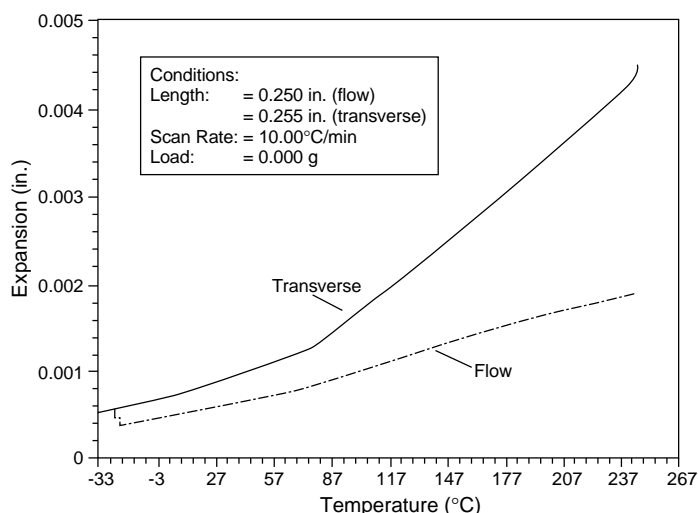

Figure 1 Dimensional change of mineral/glass-reinforced Fortron® PPS

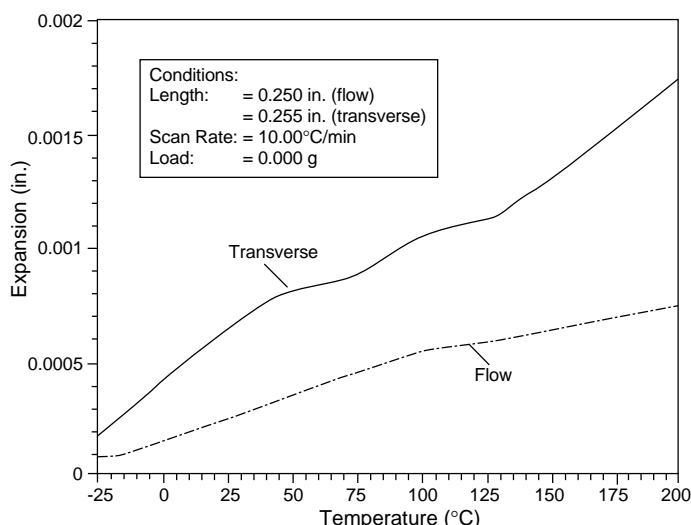

Figure 2 Dimensional change of 40% glass-reinforced Fortron® PPS

Figures 5 and 6 show the effect of injection pressure on the shrinkage of 40% glass-reinforced and 65% mineral/glass-reinforced Fortron® PPS, respectively. As injection pressure is increased, the parts are more densely packed, thus slightly decreasing shrinkage. The test piece was 80 X 80 mm, 2 mm thick, with a rectangular (4 X 2 mm) side gate at one point; the cylinder temperature was 320°C (608°F), and the mold temperature was 150°C (302°F).

Warpage

Anisotropic effects on dimensions (warping) can be caused by a number of factors, including the following:

- Mold temperature
- Nonuniform part thickness
- Nonuniform cooling
- Filler type/level

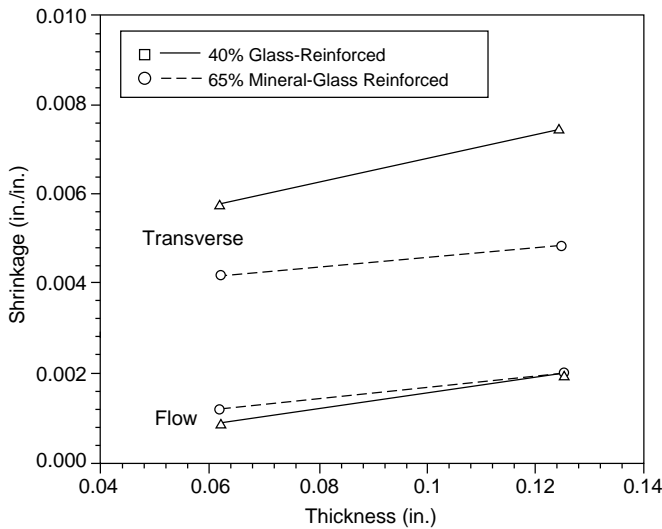

Figure 3 Effect of part thickness on shrinkage of Fortron® PPS

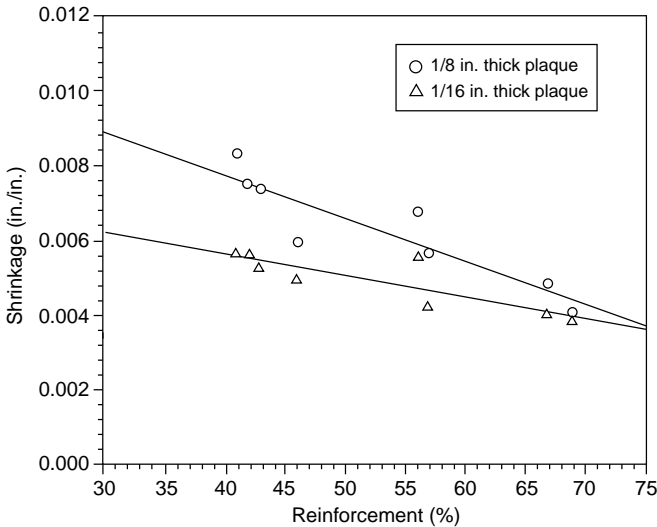

Figure 4 Effect of filler level on shrinkage of Fortron® PPS (Please note that not all reinforcement levels are available as commercial products.)

- Orientation of filler
- Location of dimensions with respect to the gate
- Molded-in stresses
- Gate size

To describe the effects of anisotropy in geometrically complex parts, a sample part containing a variety of shapes was designed. Figure 7 shows the specifications for this warpage sample. Figure 8 shows the measured points used to obtain the data shown in Figures 9 to 12, which compare the largest dimensional differences of 40% glass-reinforced and 65% mineral/glass-reinforced Fortron® PPS products with respect to flatness (Fig. 9), roundness of a cylinder (Fig. 10), roundness of a hole (Fig. 11), and bowing angle (Fig. 12).

From these figures it can be seen that 65% mineral/glass-reinforced Fortron® PPS has the least warpage,

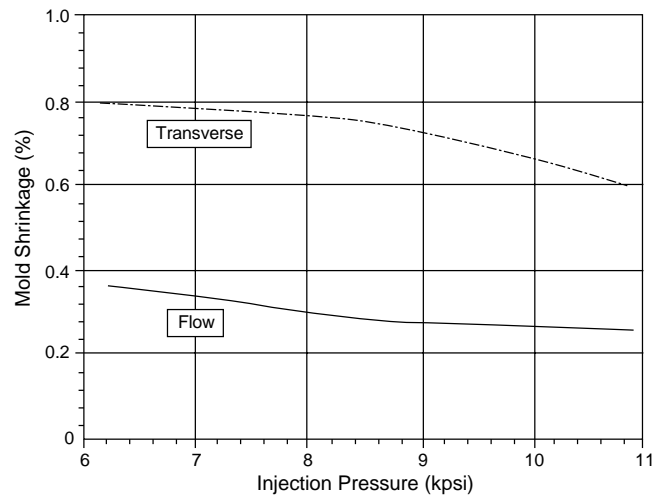

Figure 5 Effect of injection pressure on shrinkage of Fortron® PPS (40% glass)

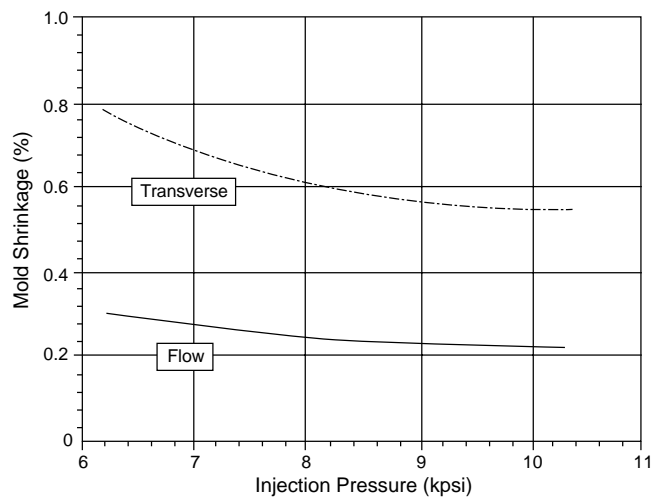

Figure 6 Effect of injection pressure on shrinkage of Fortron® PPS (65% mineral/glass)

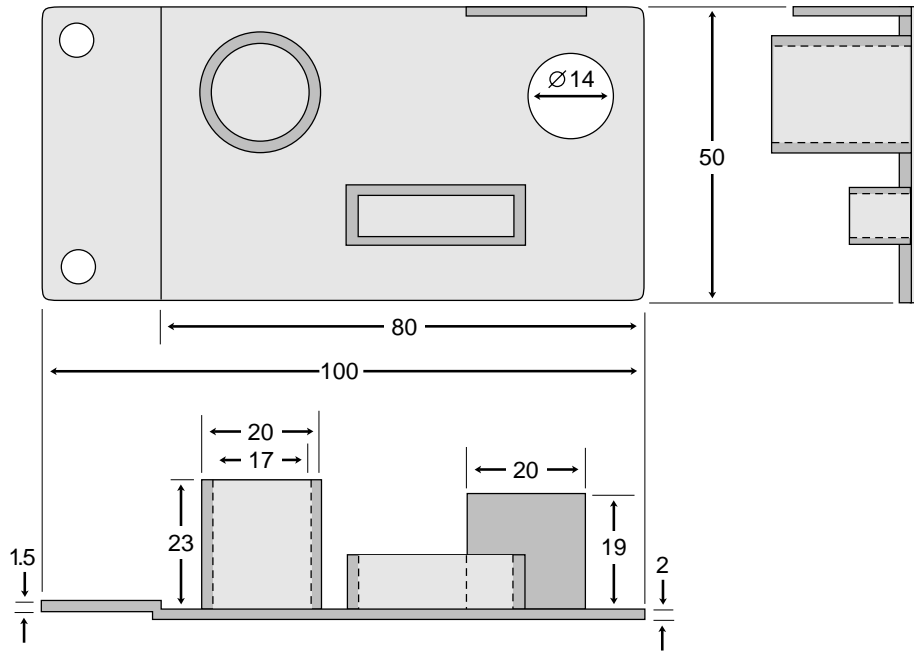

Figure 7 Specifications for warpage sample, dimensions in millimeters

due to the fact that this material uses less glass than the 40% glass-reinforced material, and that mineral filler has a smaller aspect ratio than glass fibers.

Annealing

When processed at a mold temperature of 275°F or greater, parts molded of Fortron® PPS are able to fully crystallize, and therefore, show very little continued shrinkage when exposed to temperatures as high as 450°F (232°C) for 24 h. A study of the effects of annealing Fortron® PPS products showed the following additional shrinkage values for the flow direction, using 1/8 in. thick samples:

40% Glass-Reinforced:

- 0.0009 in./in. after 2 h annealing
- 0.001 in./in. after 24 h annealing

Mineral/Glass-Reinforced

- 0.001 in./in. after 2 h annealing
- 0.0012 in./in. after 24 h annealing

Thus, there is very little advantage in annealing a sample molded at or above 275°F for more than 2 h to obtain further shrinkage.

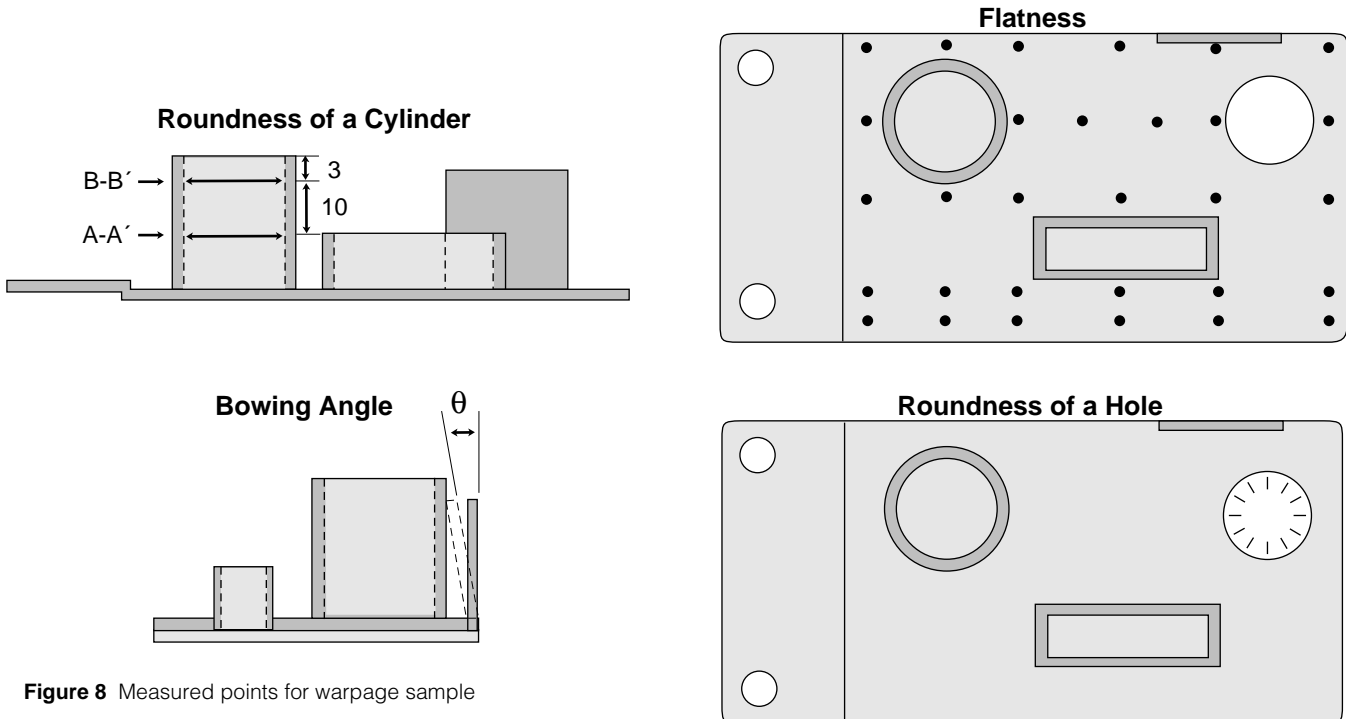

Figure 8 Measured points for warpage sample

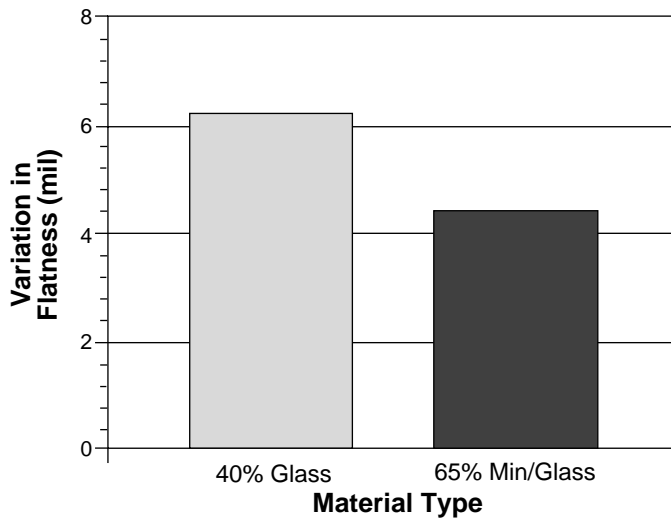

Figure 9 Warpage with respect to flatness

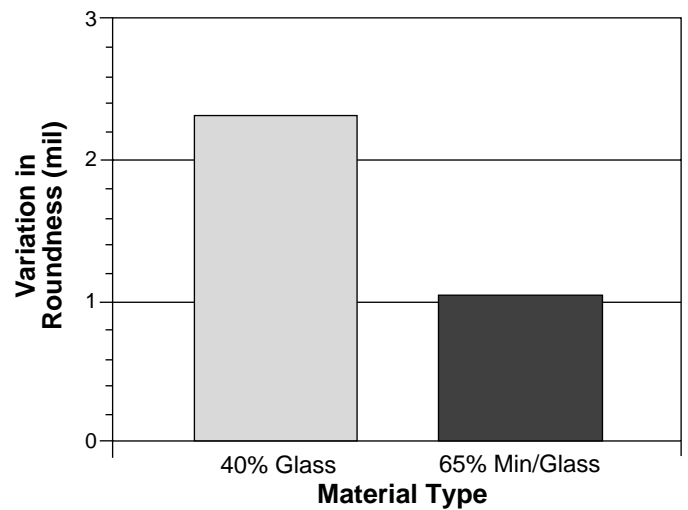

Figure 11 Warpage with respect to roundness of a hole

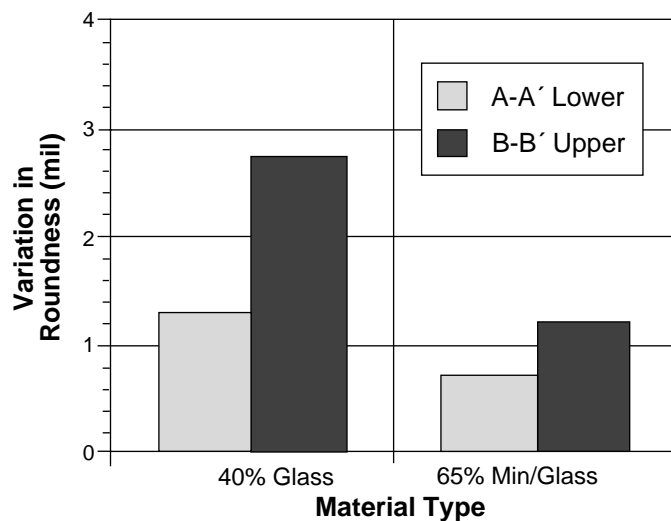

Figure 10 Warpage with respect to roundness of a cylinder

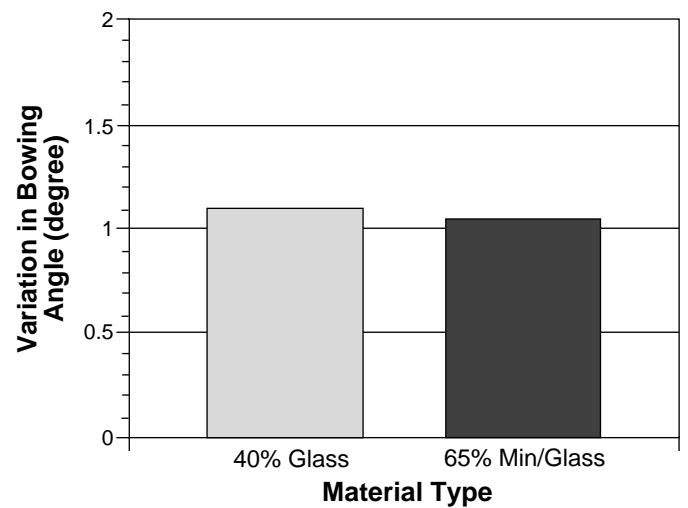

Figure 12 Warpage with respect to bowing angle

Fortron® PPS can be molded at lower mold temperatures at the expense of reduced thermal/load properties, i.e., heat distortion temperature. Annealing parts that have been molded at lower temperatures (<275°F) will increase the load-bearing capabilities of those parts, but such practice may cause warpage; thus, strict care (e.g., fixturing the part) should be taken with parts requiring critical tolerances.

Tolerances with Injection Molding

When Fortron® PPS is injection molded, it is possible to routinely hold tolerances of 2-3 mil/in. To achieve tolerances such as 1 mil/in., the material should be uniformly oriented in the direction of flow, and precision processing machinery, including at least the following parameters, should be used:

- Uniform tool heating (efficient oil flow and proper placement of cooling lines)

- Closed-loop, feedback controllers for temperatures, pressures, injection speeds, and ram distances

Table 1 demonstrates the dimensional reproducibility obtained in molding mineral/glass-reinforced Fortron® PPS for 10 months. At the end of 10 months, the variability over a 1.9593 in. dimension was ± 0.0006 in. (0.03%).

Moisture Absorption

Fortron® PPS products are not hygroscopic, and therefore, do not experience dimensional expansion like polyamides. For both 40% glass-reinforced and mineral/glass-reinforced Fortron® PPS products, a typical moisture absorption value is 0.03%, tested according to ASTM Method D-570 by immersion in water at 73°F (23°C) for 24 h. Figure 13 shows how this value compares with those of other engineering plastics under the same conditions.

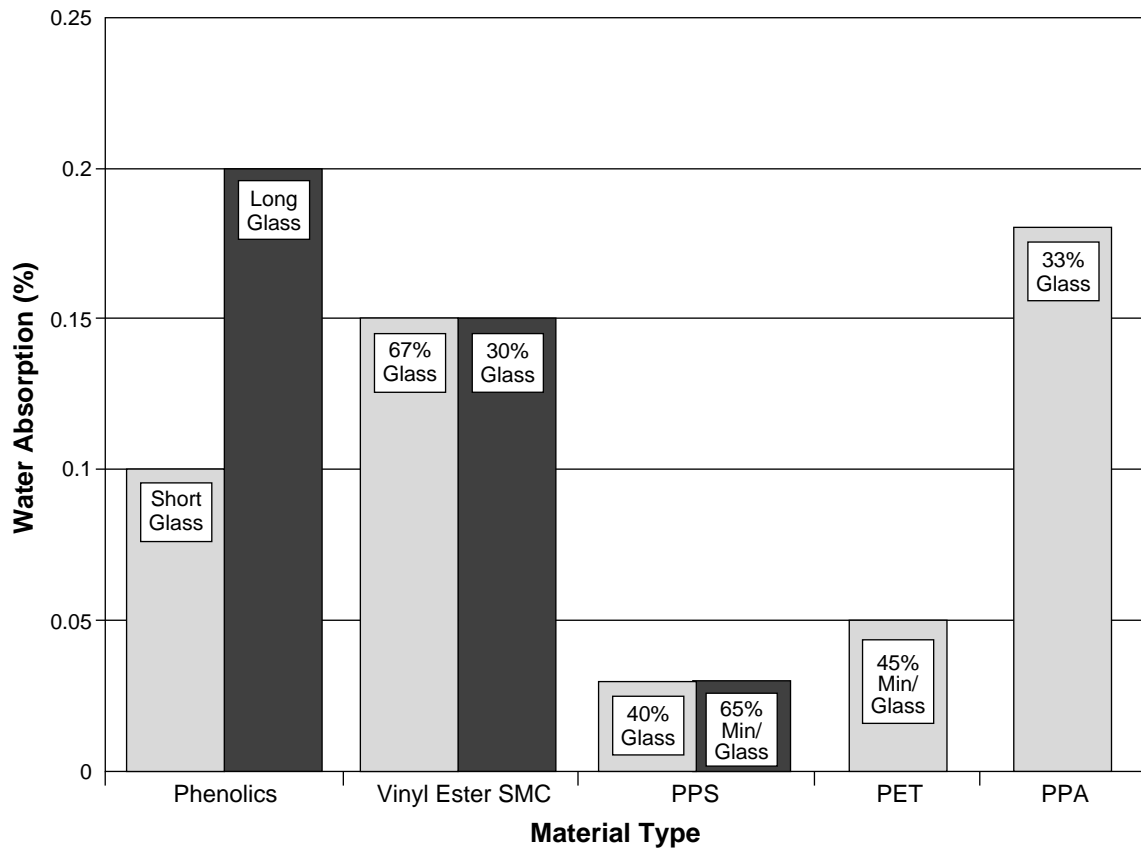

Figure 13 Comparison of the moisture absorption of several plastics by immersion in water at 73°F (23°C) for 24 h

Table 1 Long-term dimensional reproducibility of injection molding Fortron® PPS

Test Period	\bar{x} (in.)	(in.)	$3\bar{\sigma}/\bar{x}$ X 100 (%)	$3\bar{\sigma}/\bar{x}$ X 100 (%) for 3 days	Reproducibility for 9 months
Month #1 Day #1	1.9593	0.00016	0.024	0.022	Dimension = 1.9593 in. ± 0.0006 in. (0.030%)
Day #2	1.9593	0.00012	0.017		
Day #3	1.9594	0.00016	0.025		
Month #3 Day #1	1.9594	0.00016	0.026	0.025	
Day #2	1.9593	0.00016	0.025		
Day #3	1.9592	0.00016	0.025		
Month #6 Day #1	1.9592	0.00024	0.036	0.035	
Day #2	1.9591	0.00028	0.043		
Day #3	1.9592	0.00016	0.026		
Month #9 Day #1	1.9593	0.00020	0.029	0.027	
Day #2	1.9593	0.00016	0.022		
Day #3	1.9594	0.00020	0.029		

Chapter 5

Chemical Resistance

Chemical Resistance

Fortron® PPS exhibits good resistance to the effects of chemicals on its properties. It is essentially unaffected by a broad class of chemicals at elevated temperatures and for prolonged periods of time. In general, the few classes of compounds that may cause some loss of mechanical properties include strong acids, oxidizing agents, and some amines.

Effects of Hot Water

Fortron® PPS resists hydrolysis very well. Unfilled Fortron® PPS shows no significant change in properties after long-term exposure to water at high temperatures, showing the polymer's resistance to hydrolytic attack. Figure 1 shows the tensile strength retention of unfilled, 40% glass-reinforced, and mineral/glass-reinforced Fortron® PPS products after exposure to hot water at 203°F (95°C) under 15 psi.

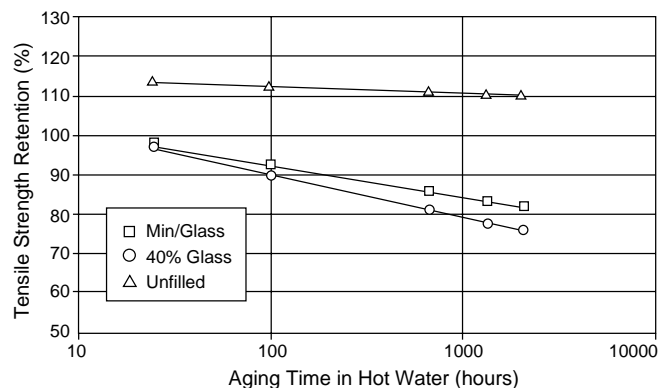

Figure 1 Tensile strength retention at break in hot water under pressure

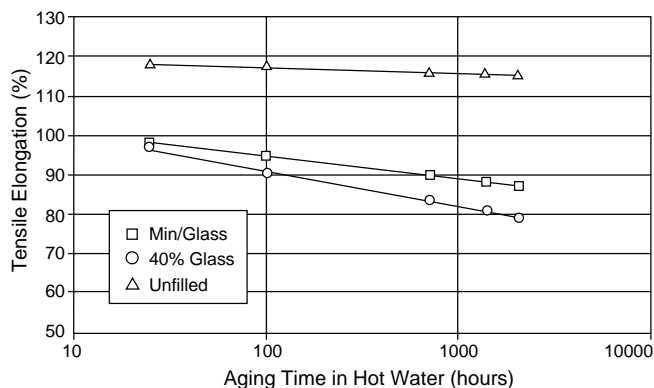

Figure 2 Tensile elongation in hot water under pressure

There is some loss of strength attributed to a reduced adhesion at the glass reinforcement/polymer interface. This phenomenon, known as the “wicking effect,” is normal for glass-reinforced plastics. The designer should compensate for this loss of strength.

Chemical Resistance

Table 1 lists the property retention ratings of a large number of chemical compounds on test specimens, ASTM Type I tensile or flexural bars, molded at a mold temperature of 275°F, using 40% glass-reinforced Fortron® PPS. The rating method is adapted from that used in *Modern Plastics Encyclopedia*; however, please note that surface effects were not evaluated.¹ Numerical data are available from Ticona marketing representatives or in material monographs.

It is important for the designer to note that the standard chemical resistance test methods (i.e., those used to prepare Table 1) are only intended to serve as a general guideline. Because the samples are not tested in the chemical environment under load, the results can be misleading for design purposes concerning the performance properties of a plastic part in a particular chemical environment under load. Therefore, the designer is strongly recommended to pursue creep rupture testing in the actual end-use environment on test bars or, preferably, prototype parts to determine the suitability of a particular plastic in such an environment.

¹ Key to chemical resistance table, as suggested in *Modern Plastics Encyclopedia*, McGraw-Hill Pub. Co., 1986-1987, p. 442:

- A = No significant effect: <0.5%, <0.2%, and <10% change in weight, dimension, and strength, respectively; slight discoloration.
- B = Significant, but usually not conclusive: 0.5-1.0%, 0.2-0.5%, and 10-20% change in weight, dimension, and strength, respectively; discolored.
- C = Usually significant: >1.0%, >0.5%, and >20% change in weight, dimension, and strength, respectively; weight warped, softened, or crazed.

Table 1 Chemical resistance of 40% glass-reinforced Fortron® PPS

Reagent (Conc.*)	Temp. (°C)	Time (days)	Tensile Elongation	Tensile Strength	Weight	Length	Thickness
Acids:							
Hydrochloric Acid (10%)	23	40	A	A	A		
Hydrochloric Acid (10%)	80	42	—	C	C	A	—
Nitric Acid (10%)	23	40	A	A	A	—	—
Sulfuric Acid (10%)	23	40	A	A	A	—	—
Sulfuric Acid (30%)	80	90	A	A	—	—	—
Alcohols:							
1-Butanol	80	180	A	A	—	—	—
Ethanol (5%)	80	180	A	A	C	A	C
Methanol	60	180	B	A	A	A	B
Methanol (60%)	55	180	A	A	A	A	A
Methanol (15%)	65	180	A	A	A	A	A
Ethylene Glycol (Antifreeze)	120	180	B	A	A	A	A
Bases:							
Sodium Hydroxide (10%)	23	40	A	A	A	A	B
Sodium Hydroxide (30%)	80	180	A	A	—	—	—
Hydrocarbons:							
Brake Fluid	80	42	—	A	A	A	A
Diesel Fuel	80	180	A	A	A	A	A
95% Fuel A/5% Ethanol	80	180	A	A	C	A	C
85% Fuel B/15% Methanol	65	180	A	A	A	A	A
40% Fuel C/60% Methanol	55	180	A	A	A	A	A
Gasoline Regular	80	125	A	A	—	—	—
Gear Oil (75W-90)	150	142	A	A	A	A	—
Kerosene	60	40	A	A	A	—	—
Lubricating Oil	60	40	A	A	A	—	—
Mineral Oil (Sat.)	120	30	A	A	A	—	—
Motor Oil	80	42	—	A	A	A	A
Refrigeration Oil	100	60	—	—	A	—	—
Toluene	80	30	—	B	—	—	—
Transmission Fluid	150	42	A	A	A	—	—
Xylene	80	180	B	A	B	A	C
Inorganics:							
Calcium Chloride (Sat.)	80	42	—	A	A	A	A
Potassium Chromate (30%)	80	42	A	A	—	—	—
Zinc Chloride (Sat.)	80	42	—	A	A	A	A
Sodium Hypochlorite (5%)	80	30	B	B	—	—	—
Deionized Water	23	180	A	A	—	—	—
Deionized Water	100	180	C	C	A	A	A

Table 1 Chemical resistance of Fortron® PPS

Reagent (Conc.*)	Temp. (°C)	Time (days)	Tensile Elongation	Tensile Strength	Weight	Length	Thickness
Ketones:							
Acetone	55	180	A	A	A	A	B
2-Butanone	58	180	B	A	A	A	A
Others:							
Butyl Acetate	80	180	A	A	—	—	—
Diethyl Ether	23	40	A	A	A	—	—
Dichlorodifluoromethane	100	60	—	A	A	B	—
Freon® 113	93	—	B	A	—	—	—
Freon® 113	23	40	A	A	A	—	—
Tetrafluoroethane	100	60	—	A	A	A	—
1,1,1-Trichloroethane	75	180	A	A	A	A	B

Freon® is a registered trademark of E.I. DuPont de Nemours & Co., Inc.

*Concentrations are assumed to be 100% unless stated otherwise.

Chapter 6

Electrical Properties

Fortron® PPS has been demonstrated to be a key high-performance polymer in the electrical/electronic industry. Because of its outstanding electrical properties, as seen in Table 1, the 40% glass-reinforced grades are used most frequently. In certain applications, glass/mineral-reinforced grades exhibiting high arc resistance and low warpage have received increased interest from this industry. Material monographs provide more specific data for individual grades of materials.

Table 1 Electrical properties of 40% glass-reinforced Fortron® PPS

Property & Conditions	Test Method	Units	Property Value
Dielectric Strength (Short Term) @ 50% RH, 73°F	ASTM D149		
0.125 in.		V/mil	380
0.0625 in.		V/mil	680
0.03125 in.		V/mil	960
Hot Wire Ignition (HWI)	UL746		
@ 1/8 in. (3.18 mm)		sec	68
@ 1/32 in. (0.81 mm)		sec	16
High Voltage Arc Tracking	UL746	in./min	4.6
Comparative Index	ASTM D3638	V	125

A sampling of electrical/electronics applications that frequently benefit from the combination of properties offered by Fortron® PPS are connectors, molded interconnects, bobbins, etc. Ticona is continuously developing specialty grades to meet the changing needs of the electrical/electronics industry.

Effect of Frequency, Humidity, and Temperature

As shown in Tables 2 and 3, the dielectric constant and dissipation factor (ASTM D-150) of 40% glass-reinforced Fortron® PPS are only minimally affected by changes in temperature, frequency, or humidity.

Figure 1 illustrates the stability of the volume resistivity of 40% glass-reinforced Fortron® PPS when aged at an elevated temperature (158°F, 70°C) and a 99%

relative humidity. Figure 2 shows the minimal effect of high temperatures alone on the volume resistivity (ASTM D-257) of Fortron® PPS.

Table 2 Dielectric constant of 40% glass-reinforced Fortron® PPS (ASTM D150)

Conditions	Dielectric Constant
@ 1MHz, 50°C, 48 h	3.90
@ 100 kHz, 50°C, 48 h	4.00
Immersion in water, 24 h	
@ 1 MHz, 23°C	3.80
@ 100kHz, 23°C	3.80
Frequency: 1 MHz	
30°C	3.90
100°C	3.95
130°C	3.97
150°C	3.95
180°C	4.90

Table 3 Dissipation factor of 40% glass-reinforced Fortron® PPS (ASTM D150)

Conditions*	Dissipation Factor
@ 73°F, 1 kHz	0.001
@ 73°F, 100 Hz, Dry	0.001
@ 73°F, 100 Hz, Wet	0.001
@ 73°F, 1 MHz, Dry	0.003
@ 73°F, 1 MHz, Wet	0.003
All at 1 MHz:	
@ 30°C	0.0015
@ 100°C	0.0015
@ 120°C	0.0018
@ 150°C	0.0022
@ 180°C	0.003

* Dry: Dried in desiccant at 23°C for 16 h.
Wet: Immersed in water at 23°C for 24 h.

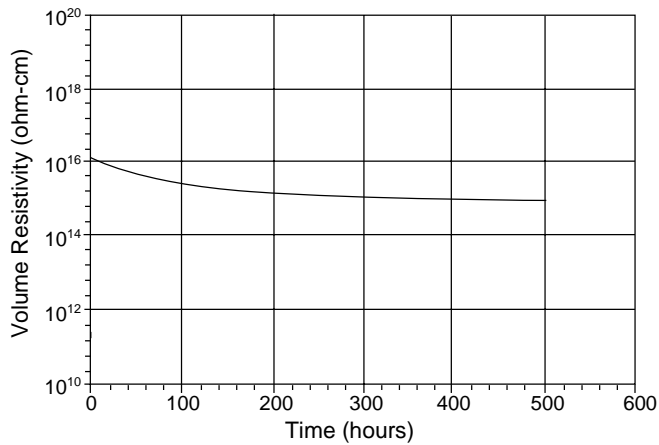

Figure 1 Stable volume resistivity of Fortron® PPS at 70°C (158°F) and 99% relative humidity

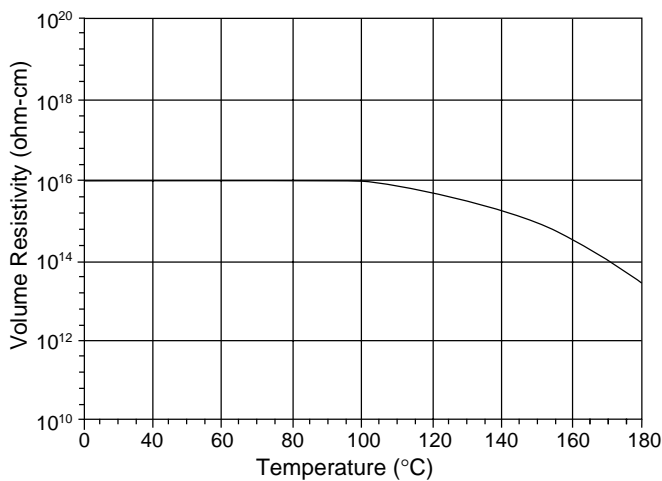

Figure 2 Effect of different temperatures on volume resistivity

Soldering Heat Resistance

Fortron® PPS shows excellent resistance to solder temperatures and dipping times, as shown in Table 4. The test piece (5 X 15 X 0.3 mm) was placed in an aluminum frame and dipped for the times and at the temperatures indicated.

Table 4 Soldering heat resistance of Fortron® PPS

Solder Temp. (°C)	Dipping Time (sec)			
	5	10	30	60
250	A	A	A	A
260	A	A	B	B
270	A	A	B	B
280	C	D	D	D

Key: A = No change; B = Discolored; C = Surface affected; D = Partially melted or deformed.

Ionic Impurities

Fortron® PPS contains few ionic impurities, e.g., Na⁺, K⁺, Li⁺, F⁻, Cl⁻, Br⁻, and SO₄²⁻. If such ions are abundant, they can adversely affect the performance of some sockets and connector housings. Excessive levels of ionic impurity can lead to the corrosion of contacts or shorts/opens in applications that are in contact with a current.¹

Furthermore, the increasing requirements due to miniaturization have led to shorter center-to-center distances for many electrical housings. Thus, the distances through which ionic impurities must migrate to cause failure is decreased. Compounding this effect are such conditions as higher temperatures and humidity levels, which accelerate the mobility (leaching) of the ionic impurities to the surface.

¹ Corbett, Tim, "Ionic Contamination in Socket Housing Materials," *Connection Technology*, Oct. 1987, p. 19.

Chapter 7

Fundamental Design Criteria

Part Design

For a broader discussion of the fundamental principles involved in plastic part design, it is recommended that the reader refer to Chapter 8, "Design Considerations for Injection-Molded Parts," of *Designing with Plastic: The Fundamentals*, published by Ticona.

Wall Thickness

The wall thickness of parts made of Fortron® PPS should be uniform throughout. To achieve uniform cooling, and thus uniform crystallization and stress relaxation, a variation of 25% of the nominal wall thickness should not be exceeded. This variation should proceed in as gradual a manner as possible, as illustrated in Figure 1, and the part should be gated so that the material flows from the thicker section to the thinner section.

A typical range of wall thicknesses with Fortron® PPS depends greatly on the flow length, injection pressure, cylinder temperature, etc. Wall thicknesses between 0.020 and 0.200 in. are common.

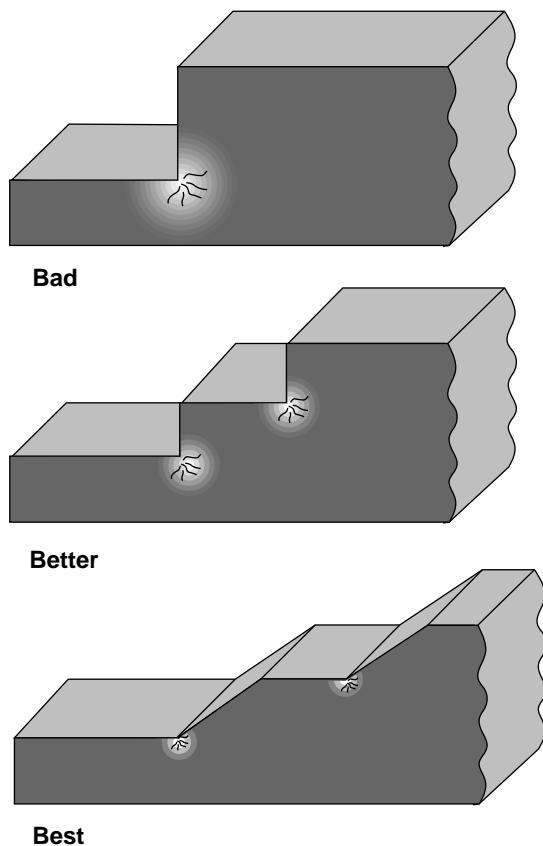

Figure 1 Design of nominal wall from thick to thin sections

Fillets/Radii

Because all PPS materials exhibit a sensitivity to notches, it is recommended that radii be incorporated for all sharp internal corners particularly those bearing loads. A minimum radius of 40% of the nominal wall thickness is suggested; however, a larger radius allows for a stronger part. Figure 2 shows the significant effect that a notch can have on the energy required to break a sample of either 40% glass-reinforced or 65% mineral/ glass-reinforced Fortron® PPS.

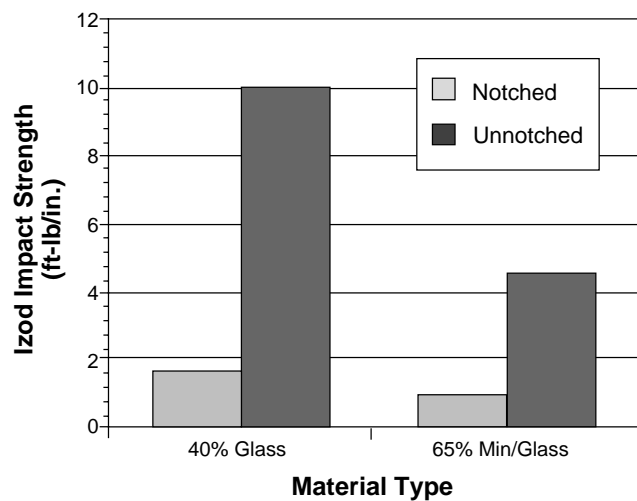

Figure 2 Effect of notches on Izod impact strength

Ribs

The use of ribs in a plastic part design allows the designer to accomplish the following objectives:

- Reduce the wall thickness
- Reduce cooling time
- Improve the flow paths
- Increase the part's strength and stiffness
- Reduce part weight
- Reduce cost

Rib height up to 3 times the wall thickness and the rib thickness half the wall thickness are recommended.

Bosses

Bosses frequently serve as fastening points for other parts, and thus, are subject to many different kinds of stresses, e.g., hoop stresses, molded-in stresses, etc. Figure 8.10 in *Designing with Plastic: The Fundamentals* may be reviewed for general principles regarding the design of bosses. Figure 3 shows the recommendations for design of a thread-cutting, self-tapping screw boss when Fortron® PPS products are used.

In applications requiring particularly high strength, metal rings for bosses can lower hoop stresses and allow for thinner walls. If thread fittings are necessary and a choice is available, mold the pipe threads onto the male part rather than on the female part.

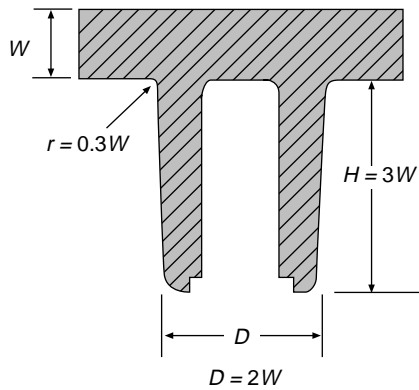

Figure 3 Design of a self-tapping screw boss

Tool Design

Tool, Screw, and Barrel Construction Materials

As is true of all filled plastic products, proper materials must be used in the construction of molds, screws, and barrel liners because glass and mineral filler materials are abrasive compounds. This is also true of PPS products.

For high-volume production parts, the recommended steels for cores and cavities are D-2, D-7, and A-2 steels, which have good wear resistance properties. For lower volume production parts, tool steels such as S-7, P-20, and H-13 are acceptable. An SPI A2 class finish is recommended. For tools that are especially difficult to vent adequately, corrosion-resistant steels D-2, D-7, and stainless steel are suitable.

The abrasive nature of glass and minerals also affects the screws and barrels. The proper materials for construction are important to ensure long life. Stellite is recommended for screws, and Xaloy 800 is recommended for barrel liners for long barrel life.

Gate Location

Gates should be located to provide a flow that is uniform and uninterrupted. Generally, the number of gates should be kept to a minimum. It is common practice to use multiple gates when dealing with a long flow length and/or thin-wall parts to reduce the pressure, and therefore, minimize flash. When multiple gates are necessary, they should be placed so that the weld lines in the product are formed in areas with minimal loadbearing requirements. Where possible, adjacent flow fronts should be forced to meet at an acute angle so that a meld line is formed. Venting at the weld line also promotes stronger welds.

Gate Size

The size of the gate is related to the nominal wall thickness. Gates should always be at least as wide as they are deep.

The high flow of Fortron® PPS materials permits the use of very small gates (as low as 0.04 in. diameter). For example, submarine or pinpoint gates typically have a 0.040-0.070 in. diameter. This smaller gate area minimizes gate vestige and provides satisfactory part separation from the runner. For edge gates, a typical starting point is 50% of the nominal wall thickness. A typical land length is 0.020 in.

Gate Types

Any kind of gate may be used for molding Fortron® PPS. It should be noted that if a submarine gate is selected, it should conform approximately to the geometry recommended in Figure 4.

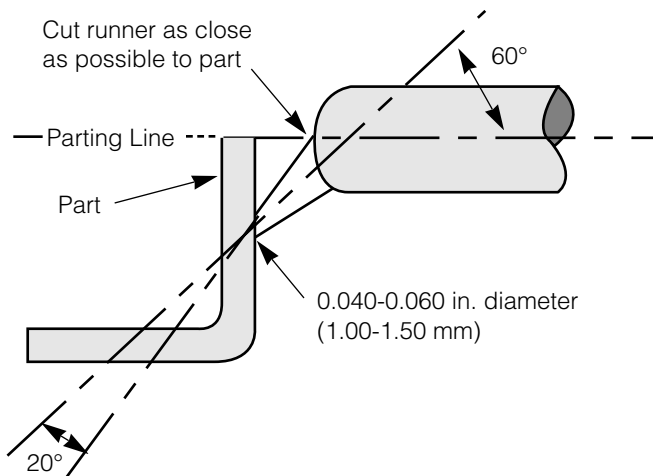

Figure 4 Specifications for submarine gates

Runner Systems

Full-round runners with a diameter as small as 0.125 in. (6 mm) are used for molding Fortron® PPS. Equivalent trapezoidal runners may also be used. When a multicavity mold is being used, it is imperative that the runner system be balanced to ensure that all cavities finish filling simultaneously, thus preventing any one cavity from being overpacked.

Vents

Vents should be located in all sections of the mold cavity where air may become trapped by the molten Fortron® PPS, particularly in the last areas to fill. The tendency of PPS to flash dictates that shallow vents, ca. 0.00030-0.0005 in. (0.007-0.012 mm), be used. Inadequate venting entraps gas, causing incomplete filling of the part, bum marks, and/or poor weld line strength. The vent land length should be about 1/8 in. and then widened to the edge of the tool.

Chapter 8

Assembly Methods

In this chapter, as with all others, the reader is encouraged to refer to *Designing with Plastic: The Fundamentals* for the fundamental principles and equations of the items discussed here, which focus on the specifics of assembly with Fortron® PPS products.

Snap-Fits

Snap-fits are commonly evaluated by calculating dynamic strain rather than stress. The maximum dynamic strain, ϵ_{max} , at ambient temperature for 40% glass-reinforced Fortron® PPS is 0.014, and that for mineral/glass-reinforced Fortron® PPS is 0.010.

In designing the finger of a snap-fit, it is extremely important to avoid any sharp internal corners or structural discontinuities, which can cause stress risers. Because a tapered finger (a 2:1 taper is usually considered typical) provides a more uniform stress distribution, it is the preferred design where possible.

Chemical Bonding/Adhesives

When adhesives are being used with Fortron® PPS products, the surface should be pretreated by wiping the surface with a solvent cleaner (methyl ethyl ketone). Successful bonds have been obtained with epoxies, urethanes, and acrylic-type adhesives. For further details, please contact your local Ticona representative.

Ultrasonic Welding

Parts made of Fortron® PPS can be ultrasonically welded. However, the joint design is critical for the strength of the finished part. A shear joint is the best design overall with Fortron® PPS parts. Table 1 gives the interference guidelines for shear joints with Fortron® PPS, while Figure 1 shows recommended dimensions for a shear joint. Tables 2 and 3 show a comparison of the ultrasonic strength of Fortron® PPS vs. highly branched PPS materials, including neat, 40% glass-reinforced, and 65% mineral/glass-filled systems. The parts tested were two caps with a wall thickness of 3 mm (1.2 in.) and a radius of 47 mm (18.5 in.). A lead-in angle of 30-45° further reduces the area of contact, pinpointing energy and maximizing shear to allow for a strong structural and hermetic seal. Due to low strength, energy directors are not recommended.

When shear joints are to be welded, use high power with a high-amplitude booster, low pressure, and a

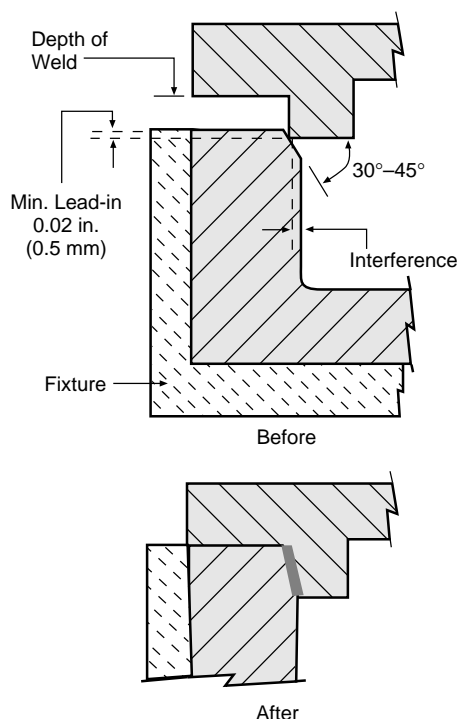

Figure 1 Recommended dimensions for shear joints

Table 1 Interference guidelines for shear joints with Fortron® PPS

Maximum Part Dimension	Interference per Side	Part Dimension Tolerance
<0.75 in. (18 mm)	0.008-0.012 in. (0.2-0.3 mm)	±0.001 in. (±0.025 mm)
0.75-1.5 in. (18-35 mm)	0.012-0.016 in. (0.3-0.4 mm)	±0.002 in. (±0.050 mm)
>1.5 in. (>35 mm)	0.016-0.020 in. (0.4-0.5 mm)	±0.003 in. (±0.075 mm)

Table 2 Comparison of the ultrasonic strength of neat Fortron® PPS vs. highly branched PPS materials

Type of Polymer	Observed Welding Results*	Weld Strength (lb)
Linear PPS		
Medium Flow	Free of cracks	990
High Flow	Cracked 1/5 times	730
Crosslinked PPS		
Medium Flow	Cracked 3/5 times	—
High Flow	Cracked 5/5 times (all)	—

* Observed welding results refer to the number of cracked parts out of all samples.

Table 2 Comparison of the ultrasonic strength of filled Fortron® PPS vs. highly branched PPS materials

Type of Material	Observed Welding Results*	Avg. Weld Strength (lb)
40% Glass-Reinforced Systems		
Fortron® PPS	Free from cracks	2690
Fortron® PPS	Free from cracks	2310
Highly Branched PPS	Cracked 1/5	1650 (n=4)
Highly Branched PPS	Cracked 5/5 (all)	—
Mineral/Glass-Reinforced Systems		
Fortron® PPS	Free from cracks	1980
Fortron® PPS	Free from cracks	1850
Highly Branched PPS	Cracked 4/5	—
Highly Branched PPS	Cracked 5/5 (all)	—

* Results refer to the number of cracked parts out of all samples (5). All welding was performed at an amplitude of 0.004 in. under a pressure of 70 psi for 0.5 sec.

slow horn speed. Caution should be used during welding of parts, since an excessively high amplitude and/or an excessively long application time could destroy the part. Care should also be exercised when highly filled mineral/glass-reinforced grades are being welded because of the lower toughness of these grades.

The follow practices in joint design should be avoided if at all possible for the reasons given:

- Joints that are either too tight or too close together may prevent adequate ventilation.
- Thin sections transmitting the ultrasonic energy may crack under high amplitude.
- Large steps requiring high power may destroy the part.
- Energy director designs will prevent a homogeneous weld.

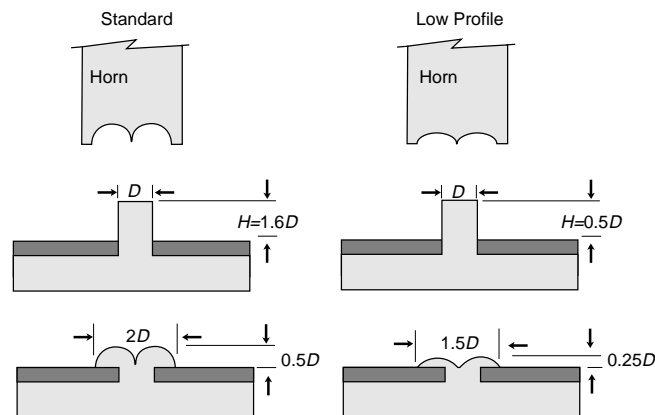

Figure 2 Dimensions for head forms for ultrasonic staking

Typical conditions for ultrasonic welding of Fortron® PPS are as follows:

- High energy
- Low pressure
- Amplitude
 - At 20 kHz, 0.0032-0.0050 in. (80-125 μm): for large parts > 2 in. diameter, both near and far field
 - At 40 kHz, 0.0019-0.0030 in. (50-76 μm): for small parts, near field only
- Vibration time: typically <1 s
- Minimum wall thickness: 0.050 in.
- Shear joint designs preferred

Heat Staking

Heat staking is a useful assembly technique for forming permanent joints between parts. Heat staking is accomplished by compressively loading the end of a rivet while the body is fixtured. The tip that performs the melting and compressing should have a Rockwell hardness of at least 60C due to the abrasive nature of the glass- and mineral-filled grades of Fortron® PPS. Fortron® PPS parts require a horn or tip temperature of about 615°F. The temperature should be sufficiently high to prevent cracking of the part, while the pressure should be sufficiently low to avoid cracking the part.

Ultrasonic Staking

Ultrasonic staking is a method of melting and reforming a plastic stud or boss to mechanically encapsulate another component. The joining component, which contains a hole, receives the Fortron® PPS stud, which is then progressively melted by the high-frequency vibrations of an ultrasonic horn, under which the stud is placed. The vibrations also cause a light, continuous pressure on the plastic stud, which is then reformed in the shape of the horn tip.

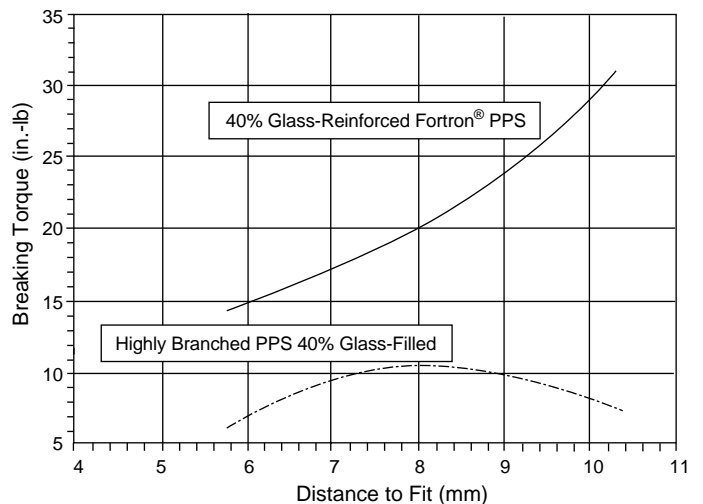

Figure 3 Breaking torque of a self-tapping screw

The requirements of most geometries are satisfied by either the standard or low-profile head-forms. The standard head-form produces a head twice the diameter of the original stud, while the low-profile head form produces a head diameter 1.5 times the stud diameter. Figure 2 illustrates these two head forms, as well as the dimensions for each.

Threading

Molding threads into the part is the preferred approach due to the excellent strength, toughness, and surface hardness of Fortron® PPS. It is important to ensure that adequate radii are incorporated to all thread roots. If this practice is not possible, use threaded inserts. The next alternative is to use self-tapping, thread-cutting screws.

The thread characteristics of Fortron® PPS can be seen by the torque required to break a part by tightening a self-tapping screw. The behavior of 40% glass-reinforced Fortron® PPS and that of a 40% glass-reinforced, highly branched PPS product are compared in Figure 3. It is significant that the highly branched PPS product was cracked as soon as it was tightened, and that little or no increase in breaking torque was seen even though the fitting was lengthened extensively.

Since Fortron® PPS is a high-modulus material, it is recommended that only thread-cutting (type BF or BT), not thread-forming, screws be used.

Metal Inserts

Metal inserts have been successfully used. When molded parts with metal inserts are subjected to repeated heat cycling, property fatigue is expected. Table 4 shows how well both 40% glass-reinforced and 65% mineral/glass-reinforced Fortron® PPS products compare in breakage with a highly branched 40% glass-reinforced PPS resin.

Table 4 Fractured pieces per 10 test pieces subjected to heat cycling

W/R	Fortron® PPS		Highly Branched
	40% Glass	65% Mineral /Glass	40% Glass PPS
0.4	0	0	0
0.3	0	0	1
0.2	0	0	2
0.1	0	2	2

Conditions: [1h at -40°C (0°F) + 1h at 150°C (302°F)] X 60 cycles.

W = Wall thickness of test piece

R = Radius of metal insert.

Secondary Operations

Machining

Because of its exceptional mechanical properties, Fortron® PPS can be machined with conventional metal-working tools. The use of tungsten carbide tipped tools is recommended when reinforced Fortron® PPS products are being machined.

A high degree of precision can be obtained in cutting operations when moderate cutting speeds, i.e., 25-40 m/min, 0.4-0.7 m/s, 80-130 ft/min), are used with fast feed rates. Slow feed results in excessive tool wear and tends to give the part a poor surface appearance. The preferred coolant is ethylene glycol (antifreeze). The tool angle should be about 10°.

Cuts (up to 1/8 in., 3.17 mm) can be made; finish cuts should remove no more than 0.005 in. (0.13 mm) of the material.

Surface Decoration

Many applications that require Fortron® PPS's high-temperature stability, chemical resistance, and desirable mechanical properties are not highly visible parts, and therefore, do not require surface decoration. However, in applications that require surface decoration, several methods, such as painting, printing, and laser beam marking, are possible with Fortron® PPS products.

Because many one-coat painting systems do not give sufficient peel strength, pretreatment with a primer is recommended. Melamine- or alkyd-type paints are recommended for the best results. A urethane-based paint has been identified as a useful primerless paint system.

Printing is also possible, but a pretreatment is again recommended. Two-component urethane-based printing inks generally have been found to give good results.

Laser beam marking has also been accomplished successfully with Fortron® PPS products.

Colorability

Because the base polymer for Fortron® PPS is a light beige, products can be compounded in a variety of colors. However, it is suggested that colored Fortron® PPS be used only for purposes of color coding, since Fortron® PPS colors tend to turn to a darker shade when exposed to heat or UV light for prolonged periods of time, or for short periods at very high temperatures. This phenomenon makes Fortron® PPS an unlikely candidate for applications requiring color matching; however, Fortron® PPS resin is well suited for color coding purposes.

As already stated, Fortron® PPS does undergo a color change at elevated temperatures. However, this color shift is not a sign of degradation and does not significantly affect the bulk properties, such as tensile strength, flexural modulus, and other mechanical and electrical properties.

Drilling and Boring

When drilling and boring Fortron® PPS, use twist drills when an angle of twist 12-16° and smooth helical flutes for removing chips. Tools should be sharpened to avoid high compressive strains which can split the material. Filled products should be heated to 150°C for 1 hour per 10mm cross-section before drilling.

Recommended drilling and boring conditions:

Point angle = 90°
Cutting speed = 50 - 200 m/min
Feed = 0.1 - 0.3 mm/revolution
Twist angle = 12 - 16°

NOTICE TO USERS: To the best of our knowledge, the information contained in this publication is accurate, however we do not assume any liability whatsoever for the accuracy and completeness of such information. Further, the analysis techniques included in this publication are often simplifications and, therefore, approximate in nature. More vigorous analysis techniques and/or prototype testing are strongly recommended to verify satisfactory part performance. Anyone intending to rely on such recommendation or to use any equipment, processing technique or material mentioned in this publication should satisfy themselves that they can meet all applicable safety and health standards.

It is the sole responsibility of the users to investigate whether any existing patents are infringed by the use of the materials mentioned in this publication.

Any determination of the suitability of a particular material for any use contemplated by the user is the sole responsibility of the user. The user must verify that the material, as subsequently processed, meets the requirements of the particular product or use. The user is encouraged to test prototypes or samples of the product under the harshest conditions likely to be encountered to determine the suitability of the materials.

Material data and values included in this publication are either based on testing of laboratory test specimens and represent data that fall within the normal range of properties for natural material or were extracted from various published sources. All are believed to be representative. Colorants or other additives may cause significant variations in data values. These values are not intended for use in establishing maximum, minimum, or ranges of values for specification purposes.

We strongly recommend that users seek and adhere to the manufacturer's or supplier's current instructions for handling each material they use. Please call 1-800-833-4882 for additional technical information. Call Customer Services at the number listed below for the appropriate Material Safety Data Sheets (MSDS) before attempting to process these products. Moreover, there is a need to reduce human exposure to many materials to the lowest practical limits in view of possible adverse effects. To the extent that any hazards may have been mentioned in this publication, we neither suggest nor guarantee that such hazards are the only ones that exist.

Fortron® polyphelyene sulfide is not intended for use in medical or dental implants.

Products Offered by Ticona

Celcon® and **Hostaform®** acetal copolymer (POM)

Celanese® Nylon 6/6

Celanex® thermoplastic polyester

Impet® thermoplastic polyester

Vandar® thermoplastic polyester alloys

Riteflex® thermoplastic polyester elastomer

Celstran®, **Fiberod®**, and **Compel®** long fiber reinforced thermoplastics

Encore® recycled thermoplastic molding resins

Fortron® polyphenylene sulfide (PPS)

GUR® ultra-high molecular weight polyethylene (UHMWPE)

GHR® specialty high density polyethylene (HDPE)

Topas® cyclic olefin copolymer (COC)

Vectra® liquid crystal polymer (LCP)

Duracon™ acetal copolymer (POM) and **Duranex™** thermoplastic polyester are offered by Polyplastics Co., Ltd.

Fortron® is a registered trademark of Fortron Industries.

Technical Information: 1-800-833-4882

Customer Services: 1-800-526-4960

Ticona

90 Morris Avenue

Summit, New Jersey 07901-3914

(908) 598-4000